

1 FRONT VIEW

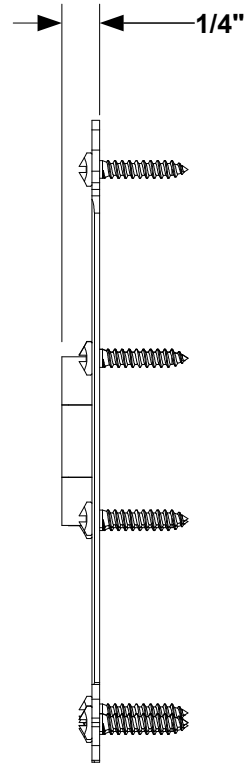

2 SIDE VIEW

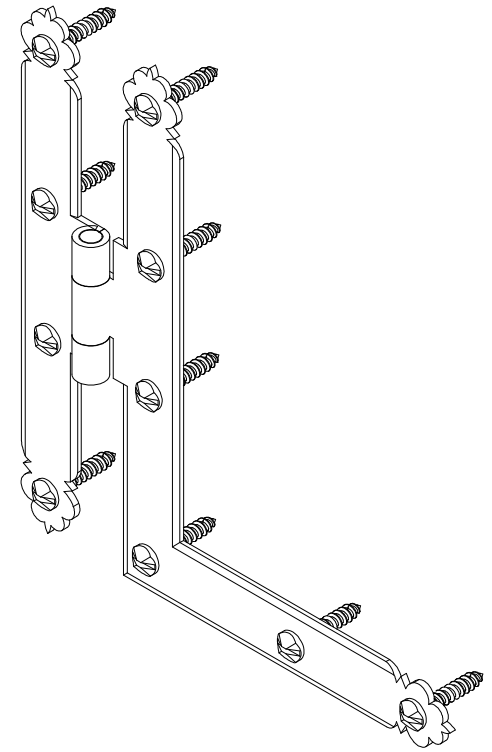

3 ISOMETRIC VIEW

NOTE: Items are hand made one at a time.
There may be slight variations in measurement and tolerances when comparing to actual Cad drawing.

CONFIDENTIALITY STATEMENT. The information contained in this Drawing, including attachments, is confidential information property of Heritage Metalworks LLC., HMW Forge and Scofield lighting. The information is intended for use solely by the individual or entity named in the message and or email sent with. Any unauthorized review, printing, copying, reproduction or distribution of such information to other parties is prohibited. If you are not an intended recipient of this, please notify Heritage Metalworks LLC. by reply e-mail and delete from your system.



Heritage Metalworks LLC

HWIR494

FOLIATED HL-HINGE, 5"

DATE: 10/25/2024

DATE REV:

DRAWN BY: JTH

FINALIZED BY: